

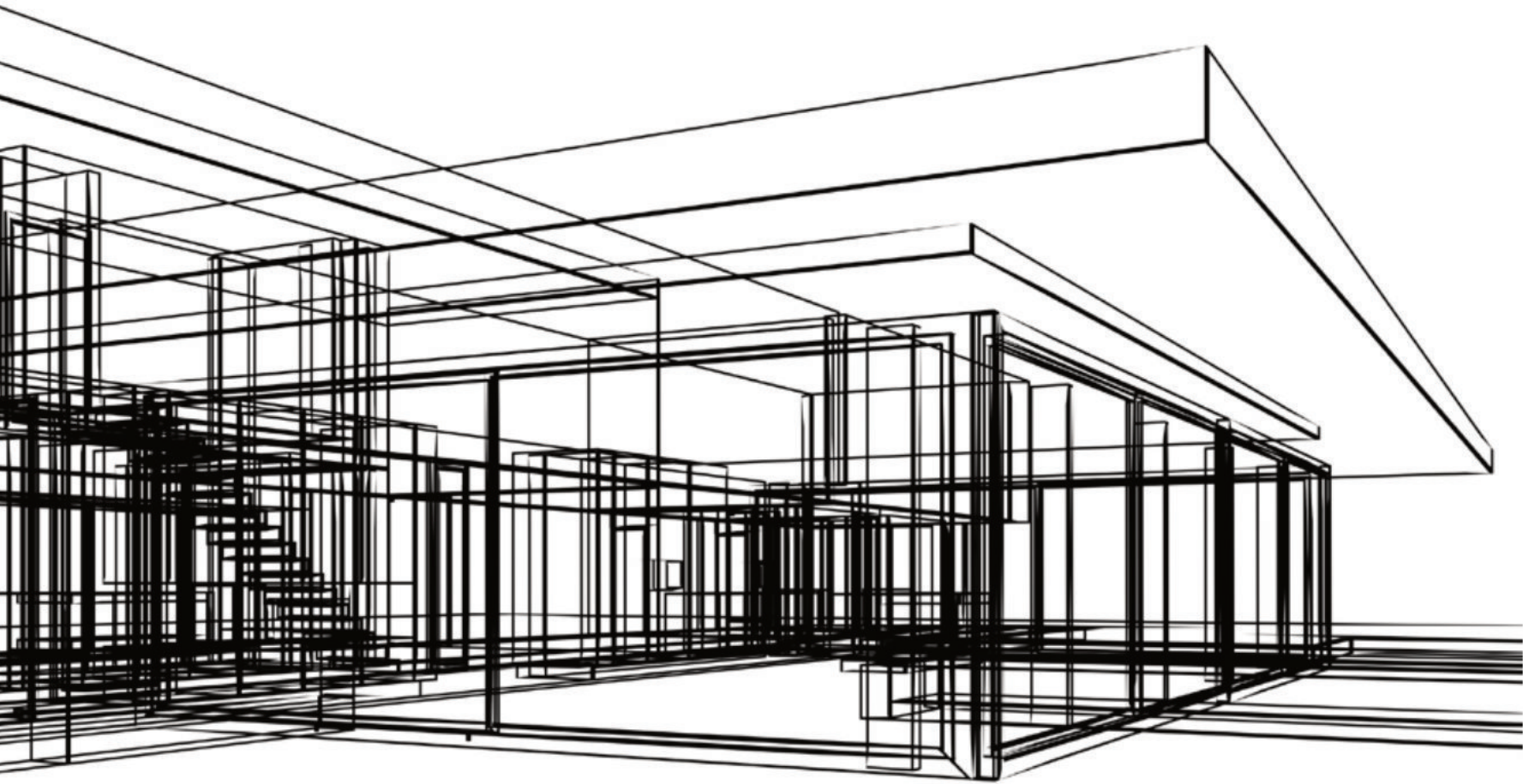

C&A[®]
CHAMA



Índice/Introdução	Recuperadores Premium	Recuperadores Cristal
2-3	10-15	16-23
Salamandras Cristal	Recuperadores a água W4	ResumoCaraterísticas
26-33	36-39	42-43



PT

A **C&A Chama** desenha, desenvolve e produz equipamentos a biomassa.

Resultado de uma experiência de mais de 20 anos no setor, em 2016 reinventa-se e cria uma nova unidade industrial na região de Aveiro. O profundo conhecimento, aliado ao enorme investimento em todo o processo produtivo dotam-nos de uma maior autonomia, eficácia e rapidez.

O reconhecimento do mercado levou à conquista de um vasto leque de clientes e fornecedores. Assim, temos como principal foco a satisfação do cliente e a garantia de qualidade dos nossos produtos.

ES

C&A Chama diseña, desarrolla y produce equipos de biomasa.

Fruto de más de 20 años de experiencia en el sector, en 2016 se reinventó y creó una nueva nave industrial en la región de Aveiro. El conocimiento profundo, combinado con la enorme inversión en todo el proceso de producción nos dota de una mayor autonomía, eficacia y rapidez.

El reconocimiento del mercado llevó a la conquista de una amplia gama de clientes y proveedores. Por lo tanto, nuestro enfoque principal es la satisfacción del cliente y la garantía de calidad de nuestros productos.

FR

C&A Chama conçoit, développe et produit des équipements de biomasse.

Issue d'une expérience de plus de 20 ans dans le secteur, elle se réinvente en 2016 et crée une nouvelle unité industrielle dans la région d'Aveiro. Les connaissances approfondies, alliées à l'énorme investissement dans l'ensemble du processus de production, nous dotent d'une plus grande autonomie, efficacité et rapidité.

La reconnaissance du marché a mené à la conquête d'un large éventail de clients et de fournisseurs. Ainsi, notre principal intérêt est la satisfaction du client et l'assurance de la qualité de nos produits.

EN

C&A Chama designs, develops, and produces biomass equipment.

Coming from an experience of more than 20 years in the sector, it reinvents itself in 2016 and creates a new industrial unit in the industrial area of Aveiro region. The in-depth knowledge, combined with the enormous investment in the entire production process, gives us greater autonomy, efficiency, and speed.

Market recognition has led to the conquest of a wide range of customers and suppliers. Thus, our main interest is customer satisfaction and quality assurance of our products.





O compromisso da **C&A Chama** centra-se na garantia sistemática da qualidade dos seus produtos e é com esta visão de futuro, profissionalismo e trabalho diário de uma equipa multidisciplinar, que se propõe satisfazer as necessidades dos clientes e assumir uma posição diferenciadora no mercado.

A **C&A Chama** exporta para mais de 10 países, sendo os principais, Espanha, França, Bélgica, Luxemburgo, Alemanha, Grécia, Chipre, Líbano, Irlanda, África do Sul e Brasil.

El compromiso de **C&A Chama** se centra en la garantía sistemática de la calidad de sus productos y es con esta visión de futuro, la profesionalidad y el trabajo diario de un equipo multidisciplinar, que se propone satisfacer las necesidades de los clientes y asumir una posición diferenciadora en el mercado.

C&A Chama exporta a más de 10 países, siendo los principales España, Francia, Bélgica, Luxemburgo, Alemania, Grecia, Chipre, Líbano, Irlanda, Sudáfrica y Brasil.

C&A Chama commitment is centered on the systematic guarantee of the quality of its products and it is with this vision of the future, professionalism and the daily work of a multidisciplinary team, that it proposes to satisfy the needs of its customers and assume a differentiating position in the market.

C&A Chama exports to more than 10 countries, the main ones being Spain, France, Belgium, Luxembourg, Germany, Greece, Cyprus, Lebanon, Ireland, South Africa and Brazil.

L'engagement de **C&A Chama** est centré sur la garantie systématique de la qualité de ses produits et c'est avec cette vision d'avenir, le professionnalisme et le travail quotidien d'une équipe pluridisciplinaire, qu'elle se propose de satisfaire les besoins des clients et d'assumer une position différenciante dans le marché.

C&A Chama exporte vers plus de 10 pays dont les principaux sont l'Espagne, la France, la Belgique, le Luxembourg, l'Allemagne, la Grèce, Chypre, le Liban, l'Irlande, l'Afrique du Sud et le Brésil.



LEGENDA:

- A. Admissão ar secundário
- 1. Lateral do Refletor Térmico
- 2. Calha Esquerdado Vermiculite
- 3. Porta
- 4. Vidro
- 5. Registo Ar Primário
- 6. Fecho
- 7. Gaveta de cinzas
- 8. Frente do Kit de Ventilação
- 9. Interruptor de controlo da ventilação
- 10. Lastro
- 11. Saída ar secundário
- 12. Deflector

SUBTITLE:

- A. Secondary air intake
- 1. Side of the Thermal Reflector
- 2. Left Gutter of Vermiculite
- 3. Door
- 4. Glass
- 5. Primary Air Register
- 6. Closure
- 7. Ash drawer
- 8. Front of the Ventilation Kit
- 9. Ventilation control switch
- 10. Ballast
- 11. Secondary air outlet
- 12. Deflector

LEYENDA:

- A. Toma de aire secundaria
- 1. Lado del Reflector Térmico
- 2. Canalón Izquierdo de Vermiculita
- 3. Puerta
- 4. Vidrio
- 5. Registro de Aire Primario
- 6. Cierre
- 7. Cenicero
- 8. Frente del Kit de Ventilación
- 9. Interruptor de control de ventilación
- 10. Lastre
- 11. Salida de aire secundario
- 12. Deflector

LÉGENDE:

- A. Admission d'air secondaire
- 1. Côté du réflecteur thermique
- 2. Gouttière gauche de vermiculite
- 3. Porte
- 4. Verre
- 5. Registre aérien primaire
- 6. Fermeture
- 7. Tiroir à cendres
- 8. Avant du kit de ventilation
- 9. Commutateur de commande de ventilation
- 10. Ballast
- 11. Sortie d'air secondaire
- 12. Déflecteur

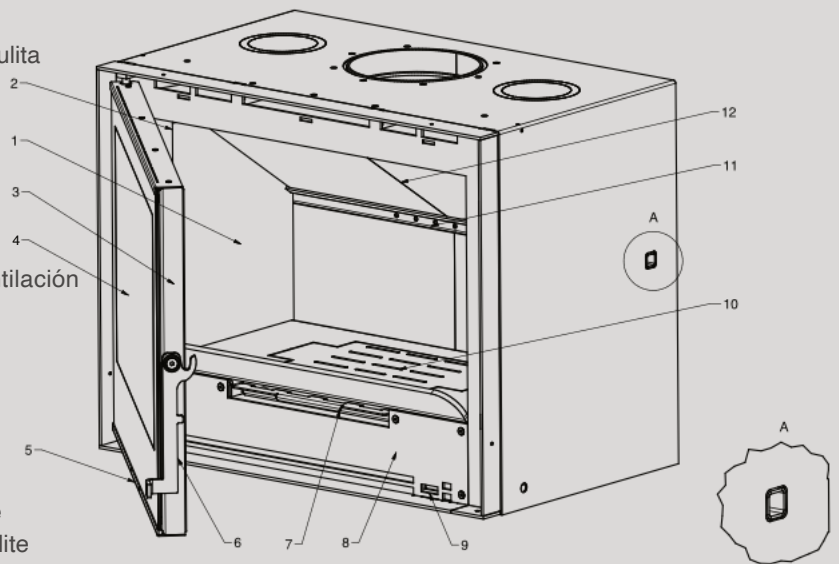

Todos os modelos equipados com Kit de Ventilação elétrica cumprem as Diretivas 2004/108/EC e 73/23/CEE, de acordo com as Normas EN 60335-1:2002 e EN 60730-1:2002 que autenticam a segurança na utilização de equipamentos de aquecimento.

Todos los modelos equipados con el Kit de Ventilación eléctrico cumplen las Directivas 2004/108/EC e 73/23/CEE, según las Normas EN 60335-1:2002 y EN 60730-1:2002 que autentican la seguridad de utilización de los equipamientos de calentamiento.

A certificação de todos os equipamentos segundo as normas EN 13229, EN 13240 respetivamente significa que a eficiência energética dos nossos equipamentos e segurança para o utilizador são direitos salvaguardados do nosso cliente.

La certificación de todos los equipos conforme a las normas EN 13229, EN 13240 respectivamente significa que la eficacia energética de nuestros equipamientos y seguridad para el usuario son derechos salvaguardados de nuestro cliente.

Tous les modèles équipés d'un kit électrique de ventilation conformes aux directives 2004/108 / CE et 73/23 / CEE, selon la norme EN 60335-1 Normes: 2002 et EN 60730-1: 2002 qui authentifient à la sécurité dans l'utilisation des appareils de chauffage.

All models equipped with electric ventilation kit comply with the Directives 2004/108 / CE and 73/23 / EEC, according to the Standards EN 60335-1: 2002 and EN 60730-1: 2002 which authenticate the safety in the use of the heating equipment.

La certification de tous les équipements selon les normes EN 13229, EN 13240 respectivement signifie que l'efficacité énergétique de nos équipements et de la sécurité pour l'utilisateur sont droits sauvegardés de notre client.

The certification of all equipment to EN 13229, EN 13240 respectively means that the energy efficiency of our facilities and security for the user are rights protected from our client.





Recuperador
Premium I



CARACTERÍSTICAS

Características/ Caractéristiques

Technical Specifications



Recuperador Premium I



Classe Energética
Clase energética
Classe énergétique
Energy class

A



Potência
Potencia
Puissance
Power

7,4kw



Rendimento
Rendimiento
Rendement
Performance

78%



Dimensões
Dimensiones
Dimensions
Dimensions

590x495x440 (AxBxC))



Diâmetro saída de fumos
Diámetro salida de humos
Diamètre d'évacuation de fumée
Diameter of smoke output

150mm



Consumo
Consumo
Consommation
Consumption

1,60kg/h



Peso
Peso
Poids
Weight

98kg

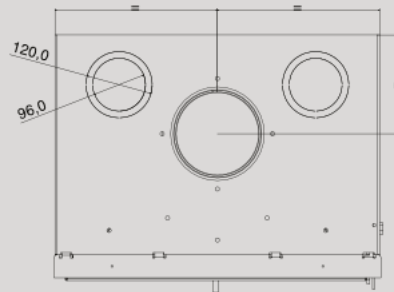
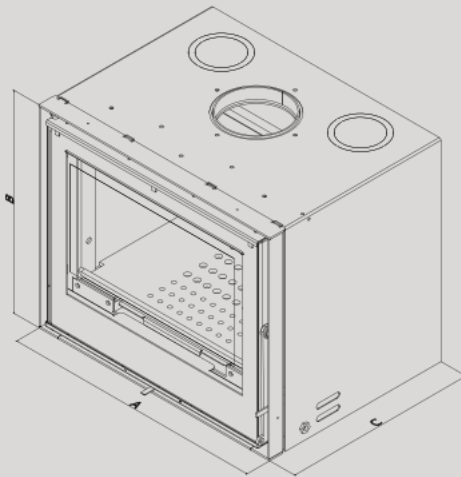
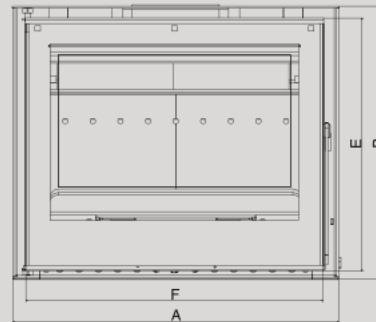

MEDIDAS

A 590mm | **B** 495mm | **C** 440mm | **D** 179mm | **E** 458mm | **F** 546mm

AROS OPCIONAIS

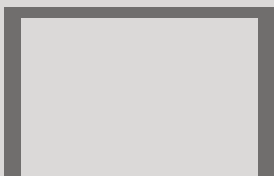

Aro 51mm 3 lados

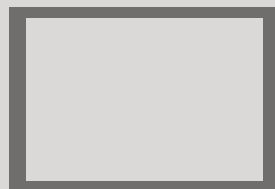

Aro 51mm 4 lados

Recuperador
Premium II



CARACTERÍSTICAS

Características/ Caractéristiques

Technical Specifications



Recuperador Premium II



Classe Energética
Classe energética
Classe énergétique
Energy class

A+



Potência
Potencia
Puissance
Power

8,4kw



Rendimento
Rendimiento
Rendement
Performance

81%



Dimensões
Dimensiones
Dimensions
Dimensions

690x495x440 (AxBxC)



Diâmetro saída de fumos
Diámetro salida de humos
Diamètre d'évacuation de fumée
Diameter of smoke outlet

180mm



Consumo
Consumo
Consommation
Consumption

1,75kg/h



Peso
Peso
Poids
Weight

105kg

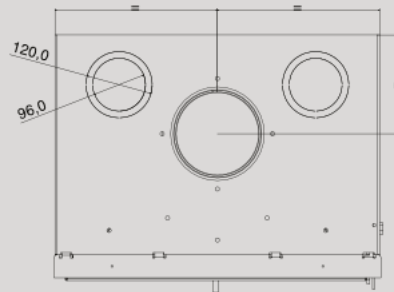
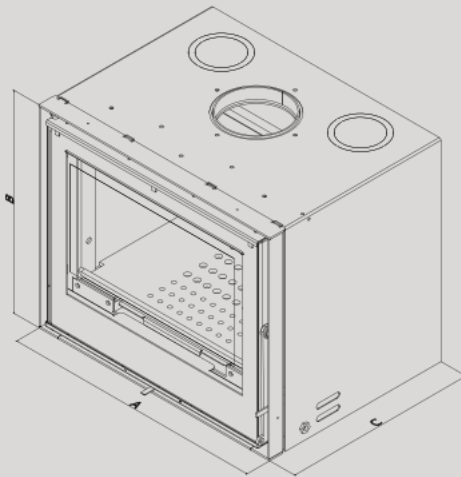
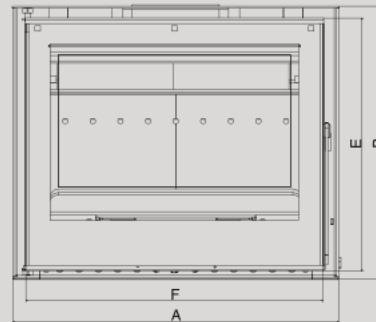

MEDIDAS

A 690mm | **B** 495mm | **C** 440mm | **D** 149mm | **E** 458mm | **F** 646mm

AROS OPCIONAIS

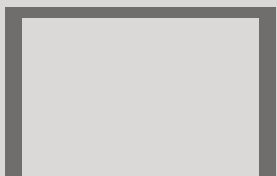

Aro 51mm 3 lados

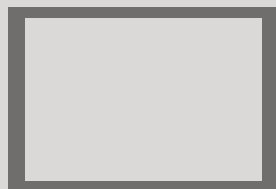

Aro 51mm 4 lados

Recuperador
Premium III

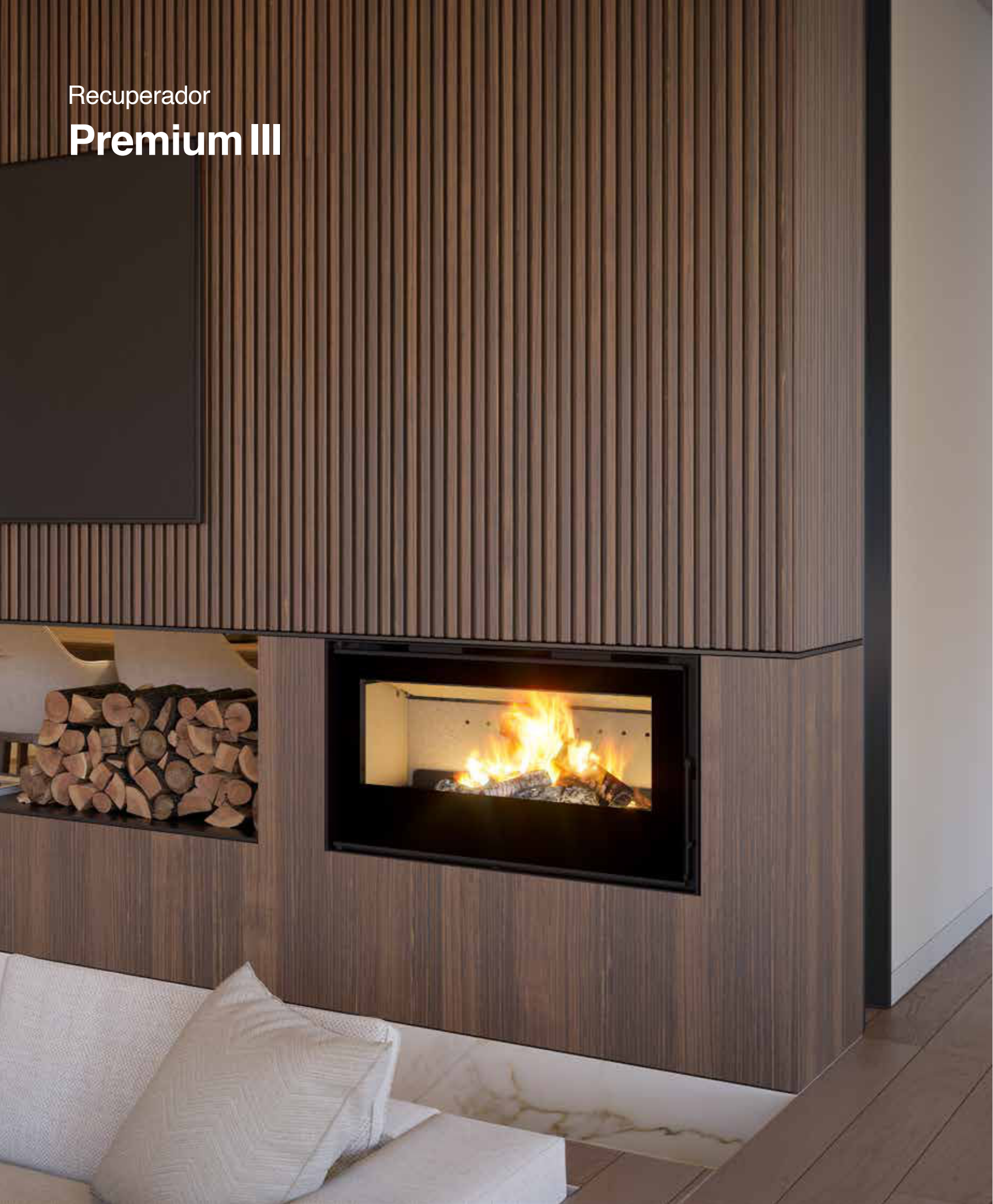

CARACTERÍSTICAS

Características/ Caractéristiques

Technical Specifications



Recuperador Premium III

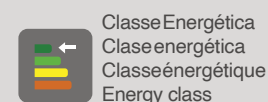

Classe Energética
Classe énergétique
Classe énergétique
Energy class

A+

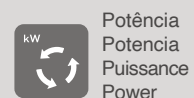

Potência
Potencia
Puissance
Power

9,4kw



Rendimento
Rendimiento
Rendement
Performance

83%



Dimensões
Dimensiones
Dimensions
Dimensions

780x495x440 (AxBxC)



Diâmetro saída de fumos
Diámetro salida de humos
Diamètre d'évacuation de fumée
Diameter of smoke output

180mm



Consumo
Consumo
Consommation
Consumption

1,90kg/h



Peso
Peso
Poids
Weight

115kg

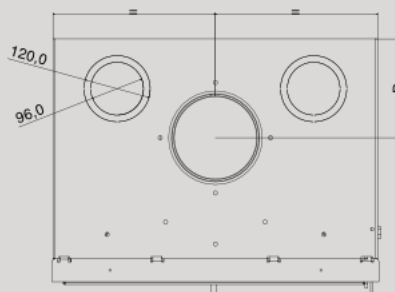
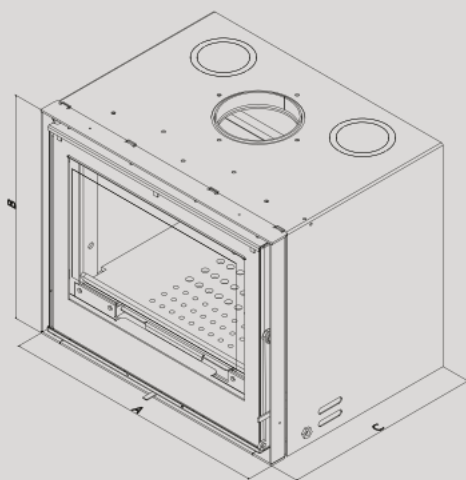
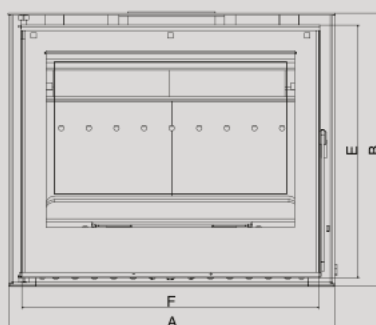

MEDIDAS

A 780mm | **B** 495mm | **C** 440mm | **D** 149mm | **E** 458mm | **F** 736mm

AROS OPCIONAIS

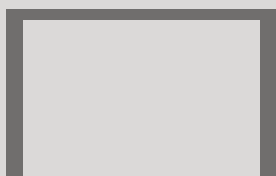

Aro 51mm 3 lados

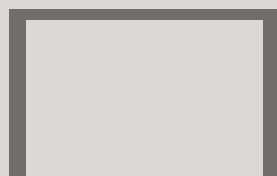

Aro 51mm 4 lados

Recuperador
Cristal 69



CARACTERÍSTICAS

Características/ Caractéristiques

Technical Specifications



Recuperador Cristal 69

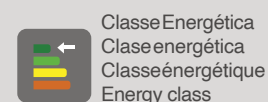

Classe Energética
Clase energética
Classe énergétique
Energy class

A+

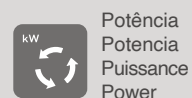

Potência
Potencia
Puissance
Power

9,8kw



Rendimento
Rendimiento
Rendement
Performance

84%



Dimensões
Dimensiones
Dimensions
Dimensions

690x548x427 (AxBxC)



Diâmetro saída de fumos
Diámetro salida de humos
Diamètre d'évacuation de fumée
Diameter of smoke output

180mm



Consumo
Consumo
Consommation
Consumption

2,70kg/h



Peso
Peso
Poids
Weight

110kg

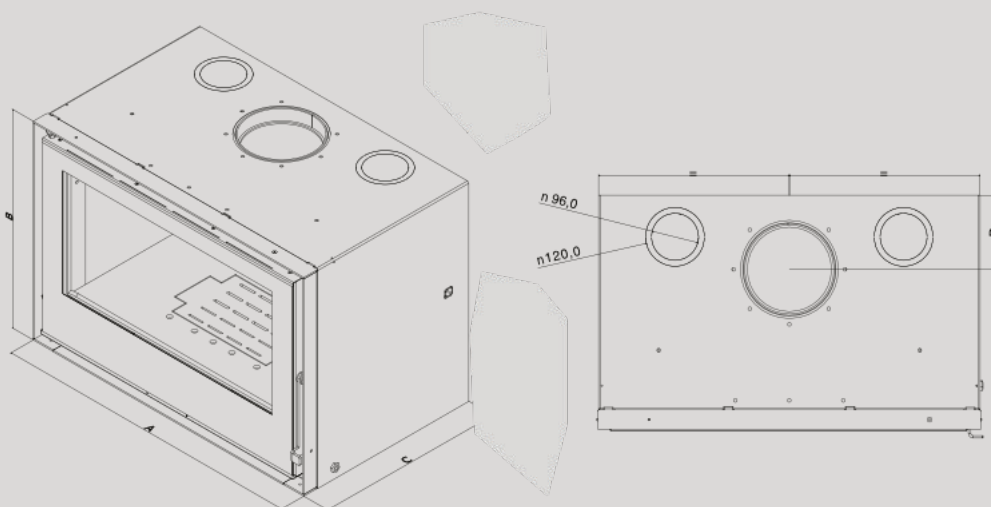
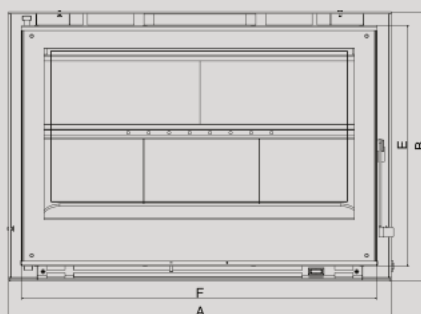
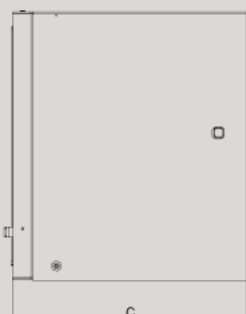

MEDIDAS

A 690mm | **B** 548mm | **C** 427mm | **D** 131mm | **E** 496mm | **F** 633mm

AROS OPCIONAIS

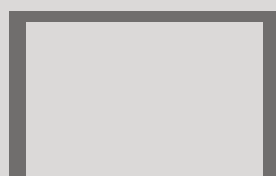

Aro 51mm 3 lados

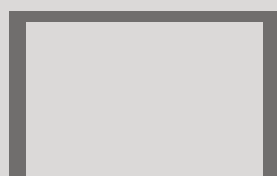

Aro 51mm 4 lados



Aro 81mm 3 lados



Aro 81mm 4 lados

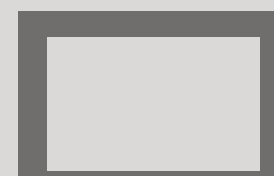

Aro 100mm em vidro

Recuperador
Cristal 78



CARACTERÍSTICAS

Características/ Caractéristiques

Technical Specifications



Recuperador Cristal 78

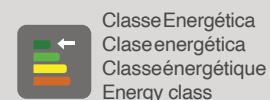

A+



10,1kw



84%



780x548x477 (AxBxC)

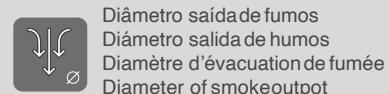

180mm



2,75kg/h



131kg

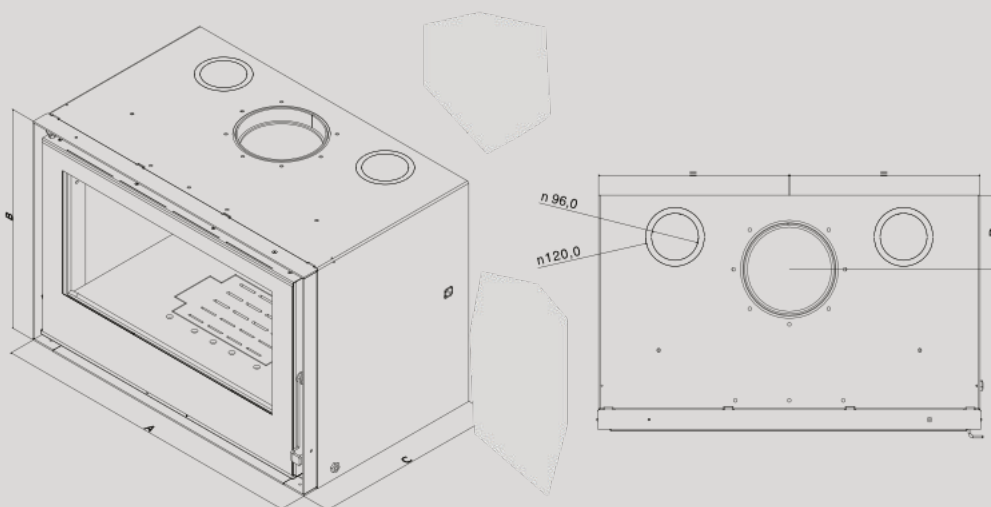
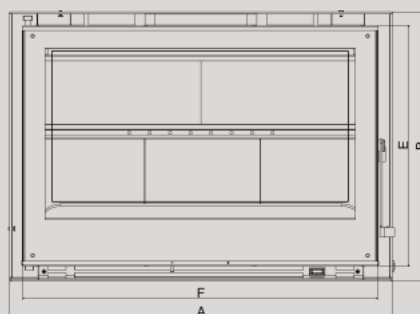
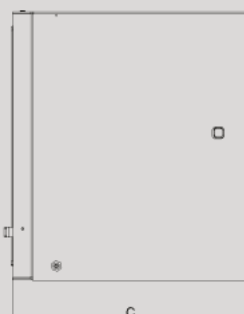

MEDIDAS

A 780mm | **B** 548mm | **C** 477mm | **D** 161mm | **E** 487mm | **F** 823mm

AROS OPCIONAIS

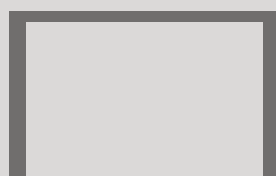

Aro 51mm 3 lados

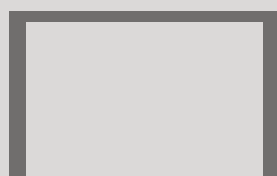

Aro 51mm 4 lados



Aro 81mm 3 lados



Aro 81mm 4 lados

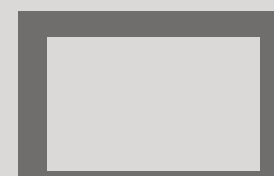

Aro 100mm em vidro

Recuperador
Cristal 88



CARACTERÍSTICAS

Características/ Caractéristiques

Technical Specifications



Recuperador Cristal 88



Classe Energética
Clase energética
Classe énergétique
Energy class

A+



Potência
Potencia
Puissance
Power

10,5kw



Rendimento
Rendimiento
Rendement
Performance

83%



Dimensões
Dimensiones
Dimensions
Dimensions

880x552x477 (AxBxC)



Diâmetro saída de fumos
Diámetro salida de humos
Diamètre d'évacuation de fumée
Diameter of smoke outlet

200mm



Consumo
Consumo
Consommation
Consumption

2,85kg/h



Peso
Peso
Poids
Weight

145kg

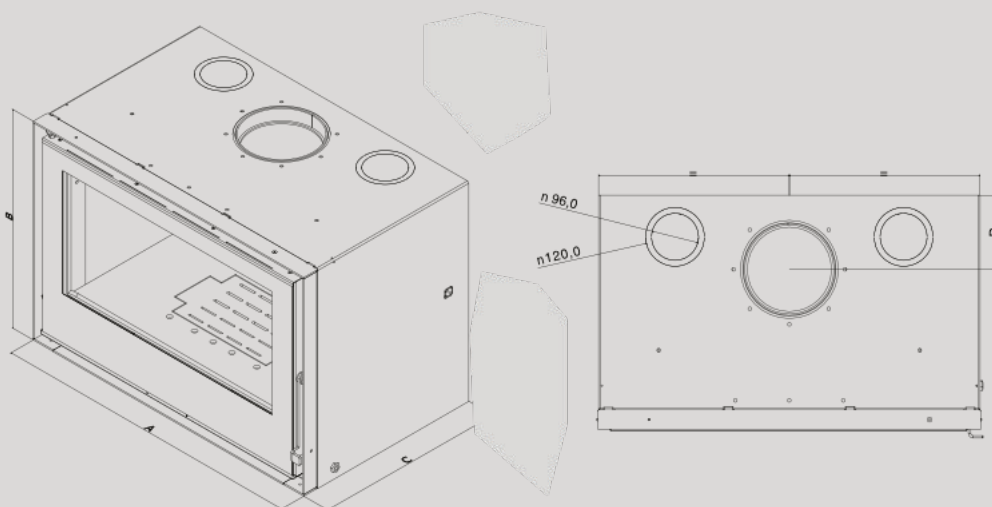
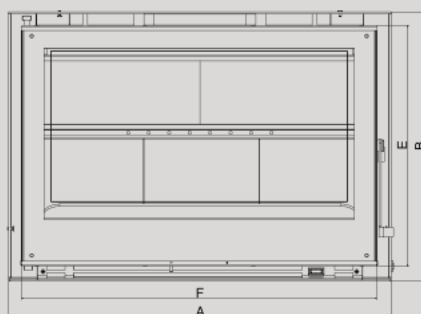
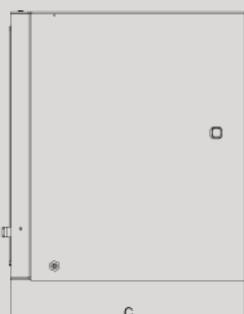

MEDIDAS

A 880mm | **B** 552mm | **C** 477mm | **D** 161mm | **E** 487mm | **F** 823mm

AROS OPCIONAIS

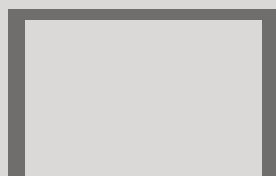

Aro 51mm 3 lados

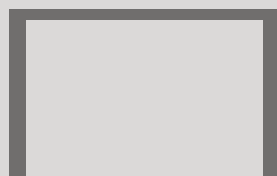

Aro 51mm 4 lados

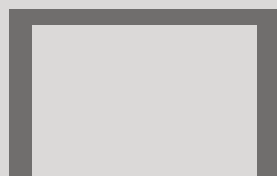

Aro 81mm 3 lados

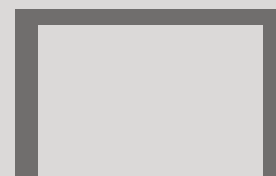

Aro 81mm 4 lados

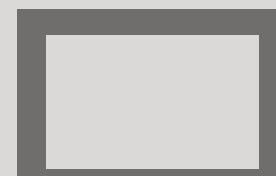

Aro 100mm em vidro

Recuperador
Cristal 98



CARACTERÍSTICAS

Características/ Caractéristiques

Technical Specifications



Recuperador

Cristal 98



Classe Energética
Clase energética
Classe énergétique
Energy class

A+



Potência
Potencia
Puissance
Power

10,8kw



Rendimento
Rendimiento
Rendement
Performance

83%



Dimensões
Dimensiones
Dimensions
Dimensions

980x552x477 (AxBxC)



Diâmetro saída de fumos
Diámetro salida de humos
Diamètre d'évacuation de fumée
Diameter of smokeoutpot

200mm



Consumo
Consumo
Consommation
Consumption

2,90kg/h



Peso
Peso
Poids
Weight

161kg

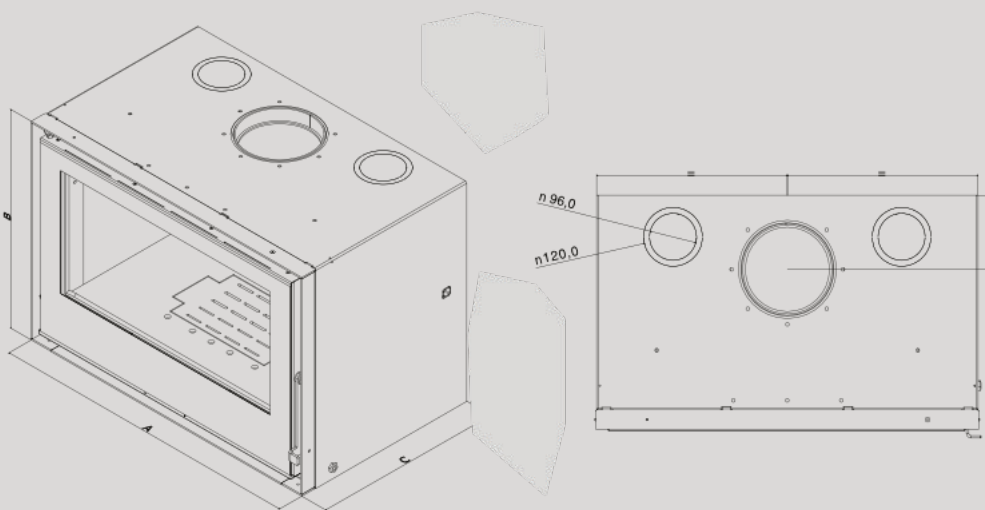
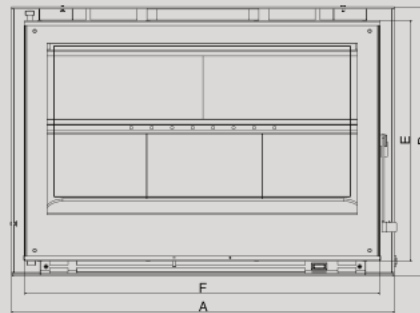
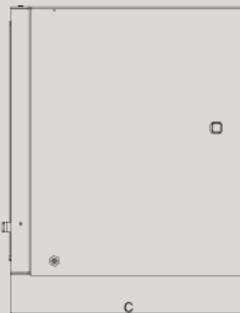

MEDIDAS

A 980mm | **B** 552mm | **C** 477mm | **D** 161mm | **E** 487mm | **F** 923mm

AROS OPCIONAIS

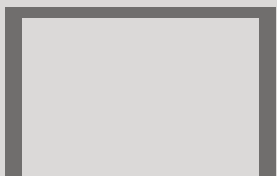

Aro 51mm 3 lados

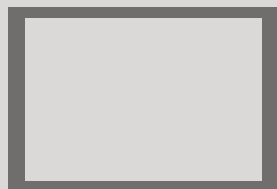

Aro 51mm 4 lados

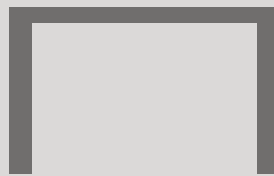

Aro 81mm 3 lados

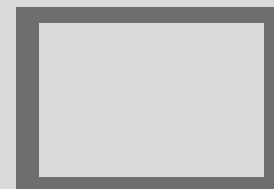

Aro 81mm 4 lados



Aro 100mm em vidro





Salamandra

Cristal 69



CARACTERÍSTICAS

Características/ Caractéristiques

Technical Specifications



Salamdra

Cristal 69



Classe Energética
Clase energética
Classe énergétique
Energy class

A+



Potência
Potencia
Puissance
Power

9,8kw



Rendimento
Rendimiento
Rendement
Performance

84%



Dimensões
Dimensiones
Dimensions
Dimensions

700x552x435 (AxBxC)



Diâmetro saída de fumos
Diámetro salida de humos
Diamètre d'évacuation de fumée
Diameter of smokeoutpot

180mm



Consumo
Consumo
Consommation
Consumption

2,70kg/h



Peso
Peso
Poids
Weight

115kg

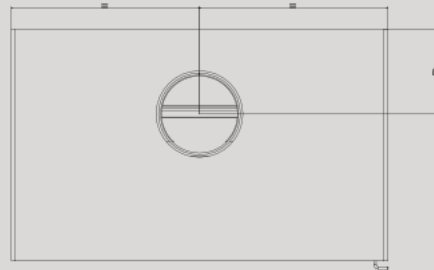
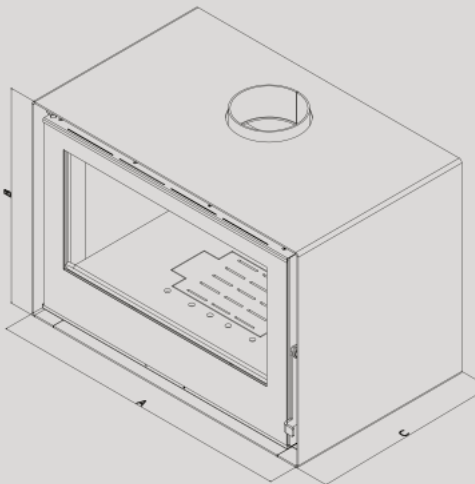

MEDIDAS

A 700mm | **B** 552mm | **C** 435mm | **D** 157mm | **E** 496mm | **F** 633mm

BASES OPCIONAIS



Base 4 pés



Pé Redondo



Base Standard



Base 2017

Salamandra
Cristal 78



CARACTERÍSTICAS

Características/ Caractéristiques

Technical Specifications



Salamdra

Cristal 78



Classe Energética
Clase energética
Classe énergétique
Energy class

A+



Potência
Potencia
Puissance
Power

10.1kw



Rendimento
Rendimiento
Rendement
Performance

84%



Dimensões
Dimensiones
Dimensions
Dimensions

790x552x485 (AxBxC)



Diâmetro saída de fumos
Diámetro salida de humos
Diamètre d'évacuation de fumée
Diameter of smoke outlet

180mm



Consumo
Consumo
Consommation
Consumption

2,75kg/h



Peso
Peso
Poids
Weight

138kg

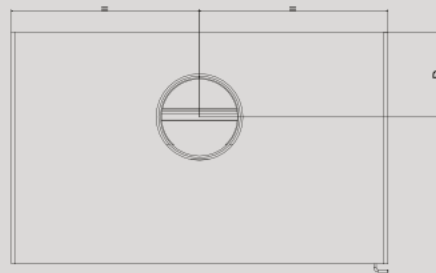
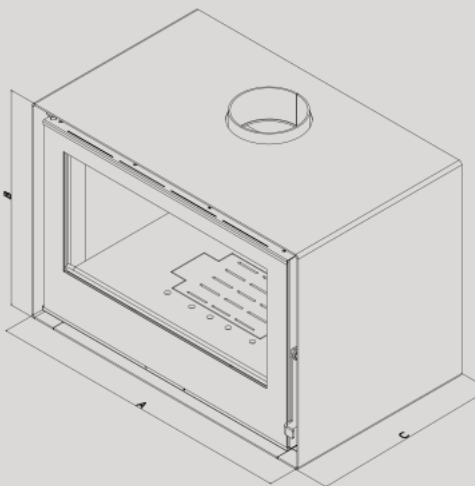

MEDIDAS

A 790mm | **B** 552mm | **C** 485mm | **D** 177mm | **E** 487mm | **F** 723mm

BASES OPCIONAIS



Base 4 pés



Pé Redondo



Base Standard



Base 2017

Salamandra

Cristal 88



CARACTERÍSTICAS

Características/ Caractéristiques

Technical Specifications



Salamadra

Cristal 88



Classe Energética
Clase energética
Classe énergétique
Energy class

A+



Potência
Potencia
Puissance
Power

10.5kw



Rendimento
Rendimiento
Rendement
Performance

83%



Dimensões
Dimensiones
Dimensions
Dimensions

890x556x485 (AxBxC)



Diâmetro saída de fumos
Diámetro salida de humos
Diamètre d'évacuation de fumée
Diameter of smoke output

200mm



Consumo
Consumo
Consommation
Consumption

2,85kg/h



Peso
Peso
Poids
Weight

155kg

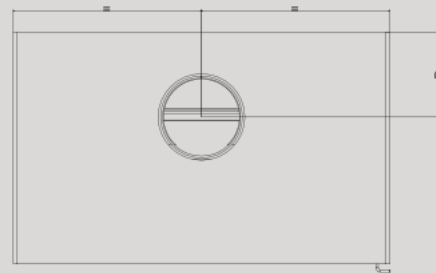
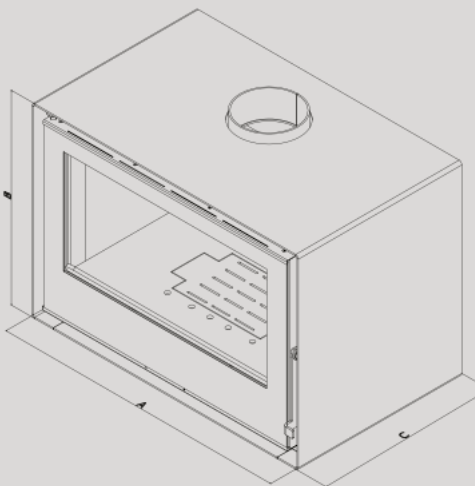

MEDIDAS

A 890mm | **B** 556mm | **C** 485mm | **D** 187mm | **E** 487mm | **F** 823mm

BASES OPCIONAIS



Base 4 pés



Pé Redondo



Base Standard



Base 2017

Salamandra

Cristal 98



CARACTERÍSTICAS

Características/ Caractéristiques

Technical Specifications



Salamadra

Cristal 98



Classe Energética
Clase energética
Classe énergétique
Energy class

A+



Potência
Potencia
Puissance
Power

10.8kw



Rendimento
Rendimiento
Rendement
Performance

83%



Dimensões
Dimensiones
Dimensions
Dimensions

990x556x485 (AxBxC)



Diâmetro saída de fumos
Diámetro salida de humos
Diamètre d'évacuation de fumée
Diameter of smoke outlet

200mm



Consumo
Consumo
Consommation
Consumption

2,90kg/h



Peso
Peso
Poids
Weight

175kg

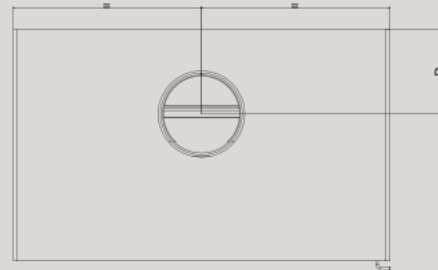
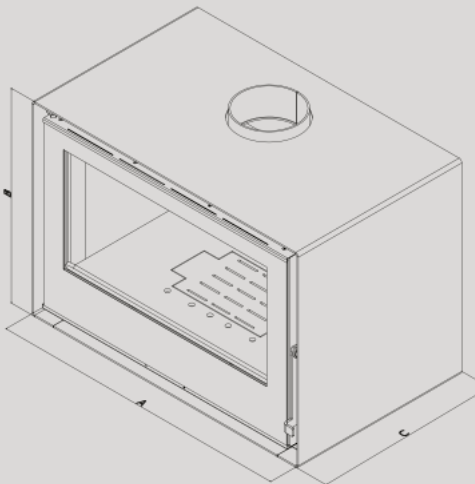

MEDIDAS

A 990mm | **B** 556mm | **C** 485mm | **D** 187mm | **E** 487mm | **F** 923mm

BASES OPCIONAIS



Base 4 pés



Pé Redondo



Base Standard



Base 2017





Recuperador a água

W4 700



CARACTERÍSTICAS

Características/ Caractéristiques

Technical Specifications



Recuperador a água

W4 700



Classe Energética
Clase energética
Classe énergétique
Energy class

A+



Potência água
Potencia agua
Puissance eau
Water power

9,5kw



Rendimento
Rendimiento
Rendement
Performance

82%



Dimensões
Dimensiones
Dimensions
Dimensions

692x550x569 (AxBxC)



Diâmetro saída de fumos
Diámetro salida de humos
Diamètre d'évacuation de fumée
Diameter of smoke outlet

200mm



Consumo
Consumo
Consumation
Consumption

3,86kg/h



Peso
Peso
Poids
Weight

223kg



Pressão máxima
Máxima presión
Pression maximale
Maximum pressure

1,5BAR



Litros
Litros
Litres
Liters

46 Litros

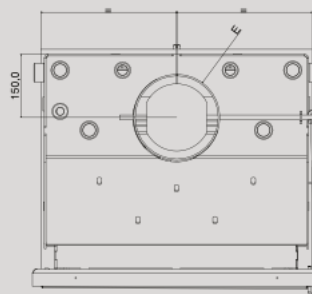
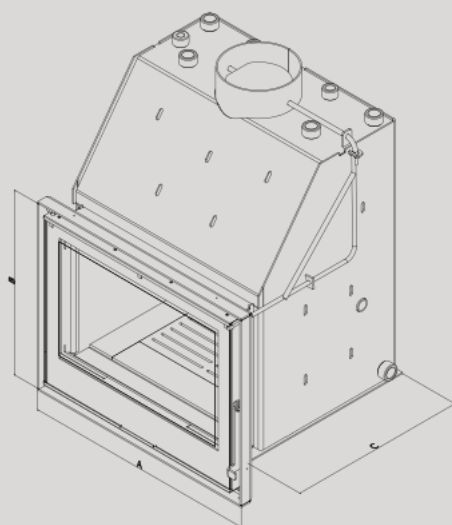
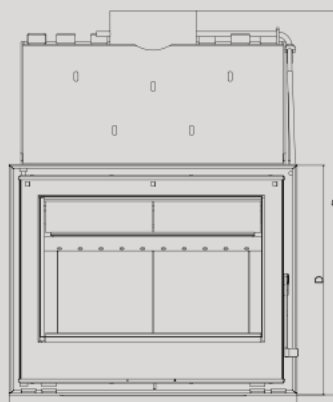
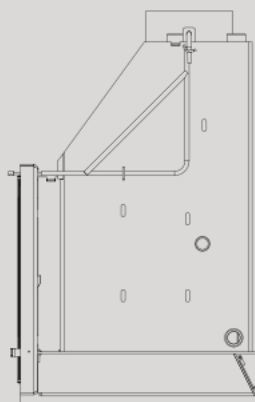

MEDIDAS

A 692mm | **B** 550mm | **C** 569mm | **D** 138mm | **E** 496mm | **F** 633mm

AROS OPCIONAIS

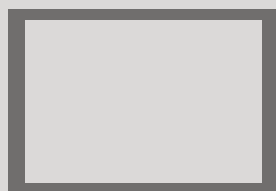

Aro 51mm 4 lados

Recuperador a água

W4 800



CARACTERÍSTICAS

Características/ Caractéristiques

Technical Specifications



Recuperador a água

W4 800

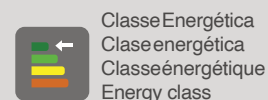

Classe Energética
Clase energética
Classe énergétique
Energy class

A+



Potência água
Potencia agua
Puissance eau
Water power

11kw



Rendimento
Rendimiento
Rendement
Performance

84%



Dimensões
Dimensiones
Dimensions
Dimensions

782x550x569 (AxBxC)



Diâmetro saída de fumos
Diámetro salida de humos
Diamètre d'évacuation de fumée
Diameter of smoke outlet

200mm



Consumo
Consumo
Consommation
Consumption

4,21kg/h



Peso
Peso
Poids
Weight

234kg



Pressão máxima
Máxima presión
Pression maximale
Maximum pressure

1,5BAR



Litros
Litros
Litres
Liters

52 Litros

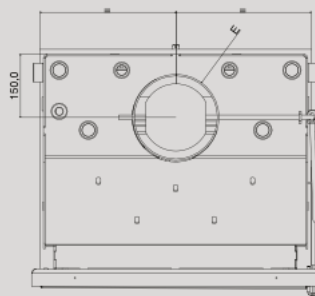
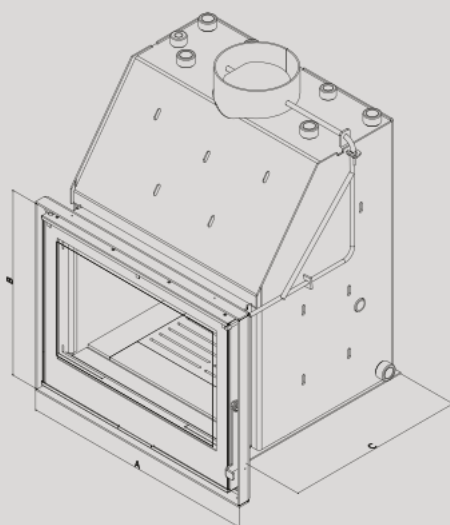
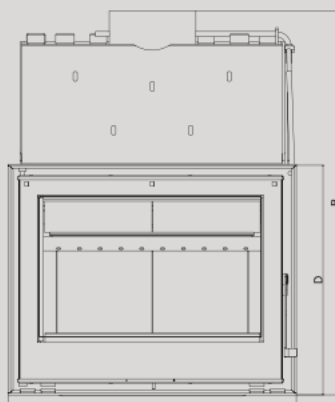
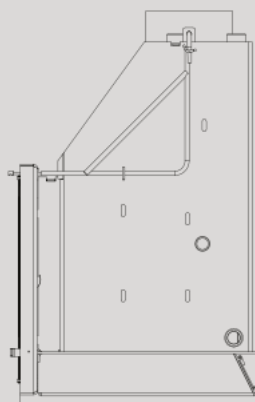

MEDIDAS

A 782mm | **B** 550mm | **C** 569mm | **D** 138mm | **E** 487mm | **F** 723mm

AROS OPCIONAIS

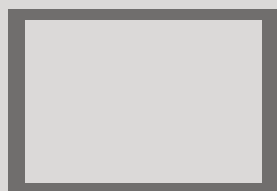



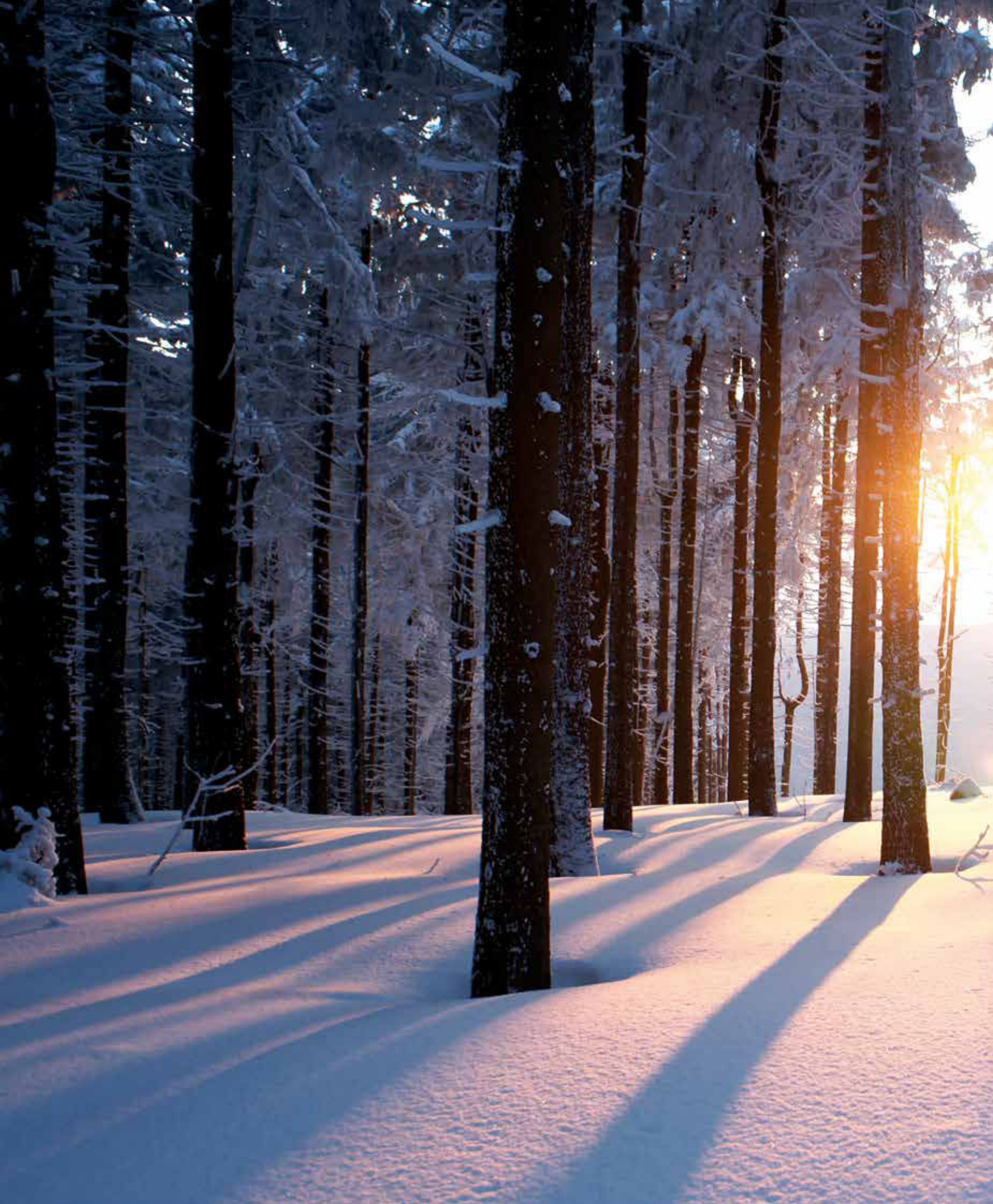



Aro 51mm 4 lados





Recuperadores

Recuperadores Premium

ESTRUTURA	Estructura Structure Struttura							
Premium I		590x495x440 (LxAxP)	78%	7,4Kw	150mm	1,60kg/h	98kg	A
Premium II		690x495x440 (LxAxP)	81%	8,4Kw	180mm	1,75kg/h	105kg	A+
Premiuml II		780x495x440 (LxAxP)	83%	9,4Kw	180mm	1,90kg/h	115kg	A+

AROSOPCIONAIS

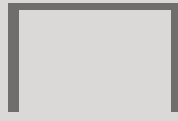

Aro 51mm3 lados

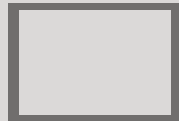

Aro 51mm4 lados

Recuperadores Cristal

ESTRUTURA	Estructura Structure Struttura							
Cristal 69		690x548x427 (LxAxP)	84%	9,8Kw	180mm	2,70kg/h	110kg	A+
Cristal 78		780x548x477 (LxAxP)	84%	10,1Kw	180mm	2,75kg/h	131kg	A+
Cristal 88		880x552x477 (LxAxP)	83%	10,5Kw	200mm	2,85kg/h	145kg	A+
Cristal 98		980x552x477 (LxAxP)	83%	10,8Kw	200mm	2,90kg/h	161kg	A+

AROSOPCIONAIS

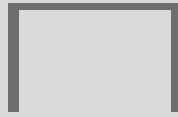

Aro 51mm3 lados

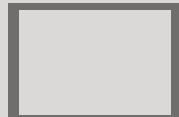

Aro 51mm4 lados

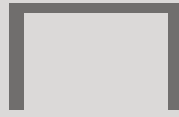

Aro 81mm3 lados

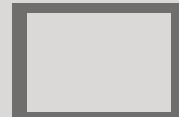









Aro 81mm4 lados



Aro 100mm vidro

Recuperadores a água W4

ESTRUTURA	Estructura Structure Struttura									
W4-700		692x550x569 (LxAxP)	82%	9,5Kw	200mm	3,86kg/h	223kg	1,5BAR	46Litros	A+
W4-800		782x550x569 (LxAxP)	84%	11Kw	200mm	4,21kg/h	234kg	1,5BAR	52 Litros	A+

AROSOPCIONAIS

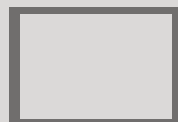

Aro 51mm4 lados

Salamandras

Salamandras **Cristal**

ESTRUTURA	Estructura Structure Struttura						
Salamandra Cristal 69	700x552x435 (LxAxP)	84%	9,8Kw	180mm	2,70kg/h	115kg	A+
Salamandra Cristal 78	790x552x485 (LxAxP)	84%	10,1Kw	180mm	2,75kg/h	138kg	A+
Salamandra Cristal 88	890x556x485 (LxAxP)	83%	10,5Kw	200mm	2,85kg/h	155kg	A+
Salamandra Cristal 98	990x556x485 (LxAxP)	83%	10,8Kw	200mm	2,90kg/h	175kg	A+

BASES OPCIONAIS



Base 4 pés



Pé Redondo



Base Standard



Base 2017



Classe Energética
Clase energética
Classe énergétique
Energy class



Potência água
Potencia agua
Puissance eau
Water power



Litros
Litros
Litres
Liters



Pressão máxima
Máxima presión
Pression maximale
Maximum pressure



Dimensões
Dimensiones
Dimensions
Dimensions



Peso
Peso
Poids
Weight



Potência
Potencia
Puissance
Power



Rendimento
Rendimiento
Rendement
Performance



Consumo
Consumo
Consommation
Consumption



Diâmetro saída de fumos
Diámetro salida de humos
Diamètre d'évacuation de fumée
Diameter of smoke output

Ruada Lagoa_Lote 10 _Zona Industrial de Olã
3770-068 Oiã (Aveiro) Portugal
+351 231 027 960
www.cea-chama.com

